



W 30 Photoelectric proximity switches: Clear signals even with low remission

	Photoelectric proximity switches, BGS
	Photoelectric proximity switches, energetic



In addition, the sensor offers a range of standard features. These include adjustable light- and dark-switching in the large terminal chamber, switching outputs that can be defined either for PNP, NPN or B configurations, and versions with optional time delay.

Fixed scanning distances of 100, 200 and 305 mm requiring alignment once only; WT 30 sensors can detect even difficult objects. Thanks to their robust housing (with a high enclosure rating of IP 67), these photoelectric proximity switches can also perform their tasks in unpleasant environments. A clear signal is generated for a machine control system even if only a small amount of light is reflected by the object.

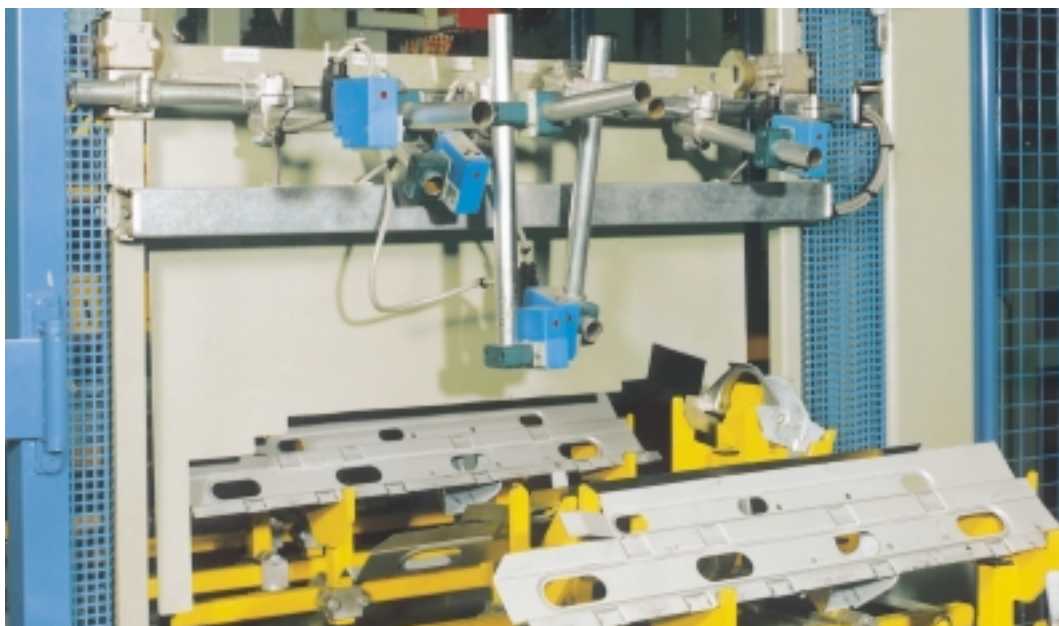

◀ Production control in a punching machine – WT 30 photoelectric proximity switches provide the solution.

▼ In a car factory, WT 30 sensors being used to ensure that windscreens are precisely positioned before they are bonded to the vehicle body.



▲ WT 30 used to check the presence of six-packs.



► WT 30 photoelectric proximity switches detecting the location of pallets to control the path of the shrink-wrapper.



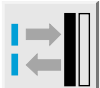

Scanning distance
100/200/300 mm

Photoelectric proximity switches

- Infrared light
- Precise background suppression
- Selectable time delays
- Terminal chamber

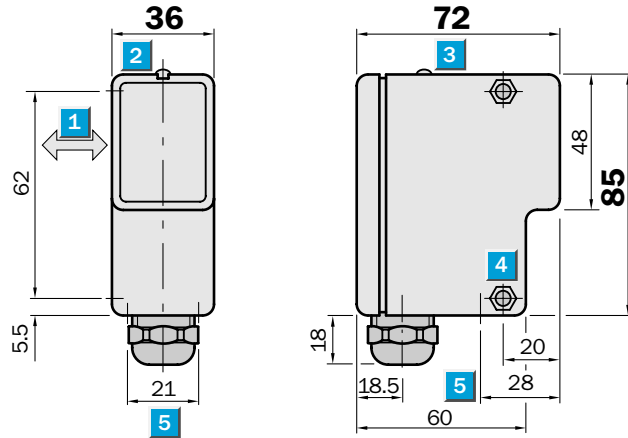
Dimensional drawing



Adjustments possible

WT 30-02	WT 30-01
WT 30-12	WT 30-11
WT 30-22	WT 30-21

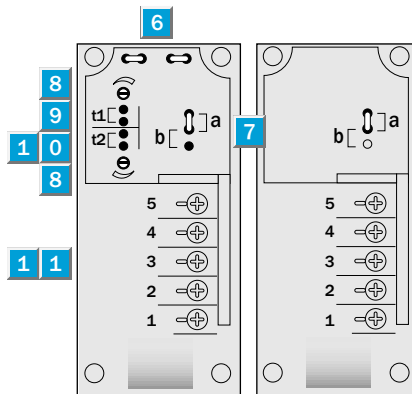

- 1** Direction of movement of the material being scanned
- 2** Alignment sight
- 3** Power indicator
- 4** Mounting holes on both sides, with recesses for M5 hex nuts
- 5** M5 threaded mounting hole – 5.5 mm deep
- 6** Holder for jumpers
- 7** Light-/dark-switching, selected via jumper
a = light-switching, b = dark-switching
- 8** Time control
- 9** ON-delay t_1
- 10** OFF-delay t_2
- 11** Terminal connections



Connection type

All types

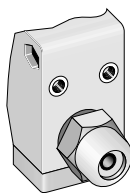

Time delay selected via jumpers

0.04 – 12 s

Jumper t_1 connected:
ON-delay

Jumper t_2 connected:
OFF-delay

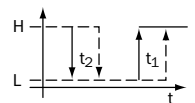

Accessories	page
Mounting brackets	510

PG 9, terminals

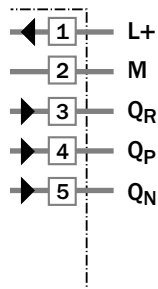

Technical data		WT 30-	01	02	21	22	11	12				
Scanning distance	300 mm		■	■								
	200 mm				■	■						
	100 mm						■	■				
Light source¹⁾, light type	LED, infrared light		■	■	■	■	■	■				
	Light spot diameter	Approx. 11 mm at 300 mm	■	■								
		Approx. 11 mm at 200 mm			■	■						
	Approx. 3.5 mm at 100 mm						■	■				
Supply voltage V_S	10...30 V DC ²⁾		■	■	■	■	■	■				
	Ripple ³⁾	< 10 V _{SS}										
	Current consumption ⁴⁾	≤ 80 mA										
Switching outputs	PNP: Q _P and NPN: Q _N		■	■	■	■	■	■				
	PNP or NPN: Q _R with current limiting ⁵⁾											
Light-/dark-switching	Selected via jumper		■	■	■	■	■	■				
Time delay	0.04...12 s			■		■		■				
Output current I _A max.	250 mA		■	■	■	■	■	■				
Response time ⁶⁾	≤ 15 ms		■	■	■	■	■	■				
Max. switching frequency ⁷⁾	30/s		■	■	■	■	■	■				
Connection type	PG screw fixing		■	■	■	■	■	■				
VDE protection class⁸⁾	⚡		■	■	■	■	■	■				
Circuit protection⁹⁾	A, B, C		■	■	■	■	■	■				
Enclosure rating	IP 67		■	■	■	■	■	■				
Ambient temperature T_A	Operation	-25 °C...+55 °C		■	■	■	■	■				
	Storage	-40 °C...+80 °C		■	■	■	■	■				
Weight	Approx. 210 g		■	■	■	■	■	■				
Housing material	Glassfibre-reinforced plastic		■	■	■	■	■	■				

1) Average service life 100,000 h at T_A = +25 °C
 2) Limit values

3) May not exceed or fall short of V_S tolerances
 4) Without load
 5) Jumper Q_P to Q_N

6) Signal transit time with resistive load
 7) With light/dark ratio 1:1
 8) Reference voltage 50 V DC

9) A = V_S connections reverse-polarity protected
 B = Output Q_P, Q_N, Q_R short-circuit protected
 C = Interference pulse suppression

Scanning distance

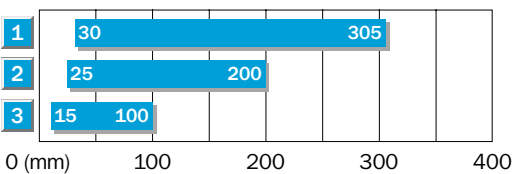

Order information

Type	Part no.
WT 30-01	1 004 179
WT 30-02	1 004 180
WT 30-21	1 004 585
WT 30-22	1 004 586
WT 30-11	1 004 489
WT 30-12	1 004 490

	1	2	3
Scanning distance on black for ¹⁰⁾ WT 30-	01/02	21/22	11/12
Tolerance of max. scanning distance	± 10 mm	± 6 mm	± 4 mm
Difference in scanning distance, black/white	± 5 mm	± 3 mm	± 2 mm

Scanning distance
100...2000 mm

Photoelectric proximity switches

- Infrared light
- Photoelectric proximity switch, energetic
- Selectable time delay
- Terminal chamber or plug

Dimensional drawing

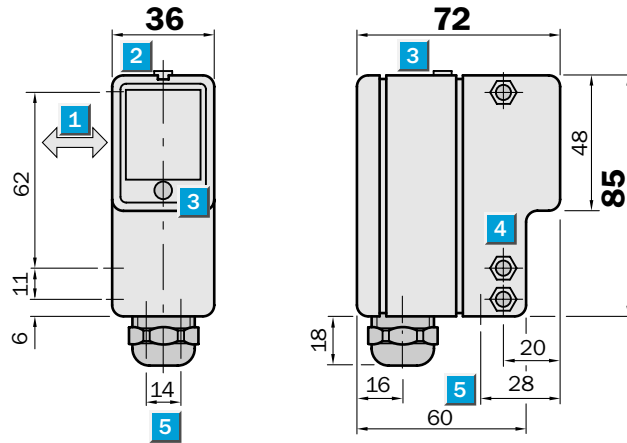

Adjustments possible

WT 32-B 230
WT 32-B 430
WT 32-B 330

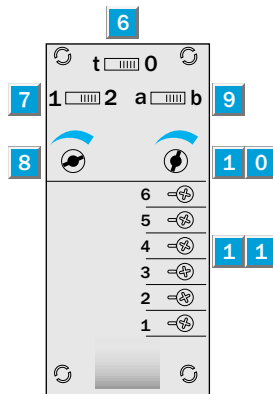

- 1** Standard direction of the material being scanned
- 2** Alignment sight
- 3** LED signal strength indicator
- 4** Mounting holes, recesses on both sides for M5 hex nuts
- 5** M5 threaded mounting hole – 5.5 mm deep
- 6** ON/OFF timer switch
t = Time ON, 0 = Time OFF
- 7** Time delay
1 ON-delay
2 OFF-delay
- 8** Time control 0.02 to 1 s
- 9** Light/dark selector
a = Light-switching
b = Dark-switching
- 1 0** Scanning distance adjustment
- 1 1** Terminal connections

Connection types

WT 32-B 230	WT 32-B 430	WT 32-B 330
-------------	-------------	-------------

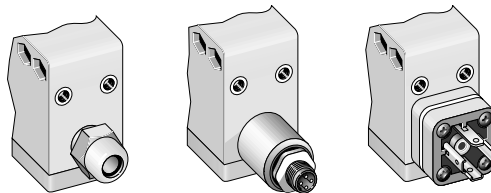

PG 11, terminals	4-pin, M 12	3-pin
------------------	-------------	-------

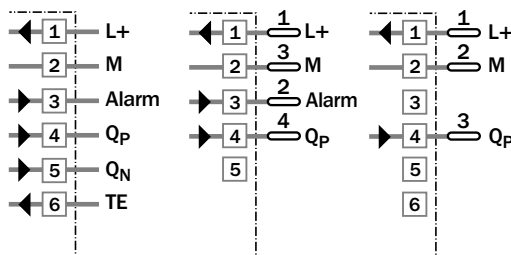

Accessories	page
Cable receptacles	496
Mounting brackets	510



Technical data		WT 32-	B 230	B 330	B 430
Scanning distance	100...2000 mm, adjustable				
Light source¹⁾, light type	LED, infrared light				
Light spot diameter	Approx. 60 mm at 2,000 mm				
Supply voltage V_S	10...30 V DC ²⁾				
Ripple ³⁾	< 5 V_{SS}				
Current consumption ⁴⁾	≤ 80 mA				
Switching outputs	PNP: Q_P and NPN: Q_N				
	PNP: Q_P or NPN: Q_N				
Light-/dark-switching	Switch-selectable				
Output current I_A max.	200 mA				
Response time ⁵⁾	≤ 5.6 ms ⁶⁾				
Pre-failure signalling output VMA	Alarm, PNP, open collection				
Operating condition "correct" ⁷⁾	Output HIGH ($V_S - 1.5$ V)				
Operating condition "faulty"	Periodic switching to V_S (5/s)				
Test input "TE"	Sender switched off				
Sender OFF	Test input to 0 V				
Connection types	PG cable gland				
	Plug				
VDE protection class⁸⁾	□				
Circuit protection⁹⁾	A, B, C				
Enclosure rating	IP 65				
	IP 67				
Ambient temperature T_A	Operation - 25 °C...+ 55 °C				
	Storage - 40 °C...+ 70 °C				
Weight	Approx. 165 g				
Housing material	Glass-fibre-reinforced plastic				

1) Average service life 100,000 h at $T_A = + 25$ °C
 2) Limit values

3) May not exceed or fall short of V_S tolerances
 4) Without load

5) Signal transit time with resistive load
 6) Without time delay
 7) Signal reserve ≥ 50 %
 8) Reference voltage 50 V DC

9) A = V_S connections reverse-polarity protected
 B = Output Q_N and Q_P short-circuit protected
 C = Interference pulse suppression

Scanning distance

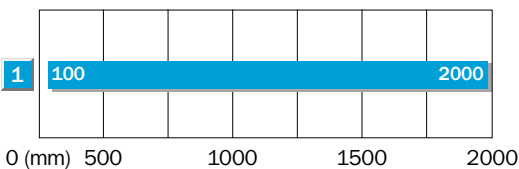

1 Scanning distance on white, 90 % remission

Order information

Type	Part no.
WT 32-B 230	1 007 397
WT 32-B 330	1 007 411
WT 32-B 430	1 011 110

Scanning distance
100...2000 mm

Photoelectric proximity switches

- Infrared light
- Photoelectric proximity switch, energetic
- Selectable time delay
- Terminal chamber

Dimensional drawing

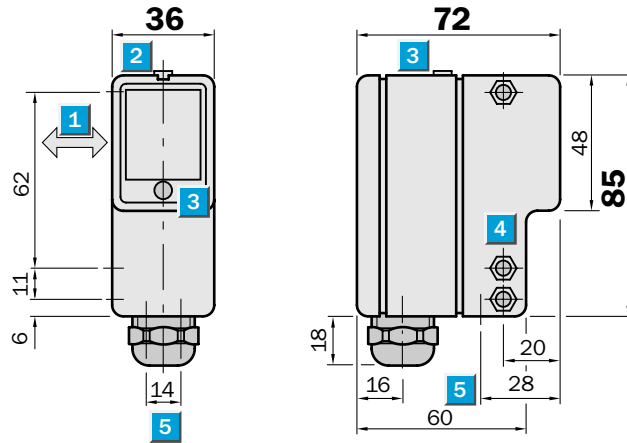

Adjustments possible

WT 32-R 230

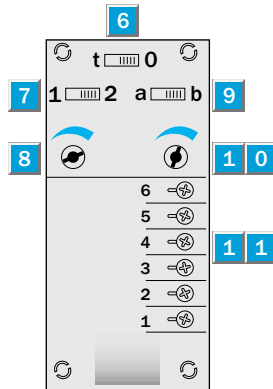

- 1** Standard direction of the material being scanned
- 2** Alignment sight
- 3** LED signal strength indicator
- 4** Mounting holes, recesses on both sides for M5 hex nuts
- 5** M5 threaded mounting hole – 5.5 mm deep
- 6** ON/OFF timer switch
t = Time ON, 0 = Time OFF
- 7** Time delay
1 ON-delay
2 OFF-delay
- 8** Time control 0.5 to 12 s
- 9** Light/dark selector
a = Light-switching
b = Dark-switching
- 1 0** Scanning distance adjustment
- 1 1** Terminal connections

Connection type

WT 32-R 230

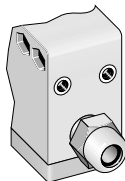

PG 11, terminals

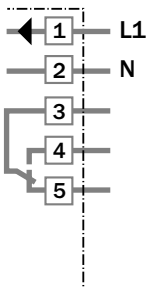

Accessories	page
Mounting brackets	510

Technical data		WT 32-	R 230										
Scanning distance	100...2000 mm, adjustable												
Light source¹⁾, light type	LED, infrared light												
Light spot diameter	Approx. 60 mm at 2,000 mm												
Supply voltage V_S	24...240 V UC (+ 10 % / - 25 %)												
Power consumption	≤ 2 VA												
Switching output	SPDT, isolated ²⁾												
Max. switching voltage	AC: 250 V / DC: 120 V												
Max. switching current	4 A / 240 V AC or 24 V DC												
Max. switching capacity	AC: 1000 VA / DC: 100 W												
Response time ³⁾	≤ 20 ms												
Light-/dark-switching	Switch-selectable												
Time delay	0.5...12 s												
Connection type	PG cable gland												
VDE protection class⁴⁾	□												
Circuit protection⁵⁾	A, C												
Enclosure rating	IP 67												
Ambient temperature T_A	Operation - 25 °C...+ 55 °C												
	Storage - 40 °C...+ 70 °C												
Weight	Approx. 200 g												
Housing material	Glass-fibre-reinforced plastic												

- 1) Average service life 100,000 h at T_A = + 25 °C
- 2) Provide suitable spark suppression for inductive or capacitive loads
- 3) With light/dark ratio 1:1
- 4) Reference voltage 250 V AC
- 5) A = V_S connections reverse-polarity protected
C = Interference pulse suppression

Scanning distance	Order information
	Type
	Part no.
	WT 32-R 230
	1 007 413

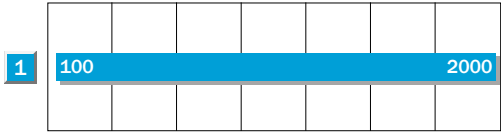

1 Scanning distance on white, 90 % remission